



R&F

HANDMADE
PAINTS

R&F Basic Encaustic Manual

Basics of Working with Encaustics

Beginning Your Adventure

There is always an initial excitement when you begin working in a new medium. This booklet will provide you with basic information, ideas and helpful hints to start your experience in encaustics positively.

We will cover information including:

- General information about encaustic paints
- Setting up a safe and useful workspace
- Suggestions for tools and equipment
- Appropriate supports and grounds
- Basic methods and helpful hints for working with encaustics
- Building your toolbox of techniques



Introduction to Encaustics

What is Encaustic Paint?

Encaustic paint is composed of beeswax, damar resin, and pigment. Encaustic is perhaps the most beautiful of all artists' paints because of the way in which the wax captures and reflects light, creating a luminous appearance. Because encaustic is impervious to moisture, it is one of the most durable artists' paints. Beeswax alone is relatively soft and does not harden. Resin is added to raise the melting temperature of the wax and to give it hardness. This makes it more durable and able to take a higher polish.



Ready? Melt, Apply, Fuse

Since encaustic paint is beeswax-based it needs to be kept molten on a heated palette to be applied to a ground. The basic technique of encaustic is to melt the paint, apply it, and then fuse (or re-heat) the surface to bond each layer. The word encaustic comes from the Greek word *enkaiein*, meaning to burn in, which refers to this process.

One of the many benefits of working with encaustic paint is that it can be polished to a high gloss, carved, scraped, layered, collaged, dipped, cast, modeled, sculpted, textured, and combined with oil. The paint cools almost immediately, so that there is no drying time, yet it can always be reworked.

Have we mentioned that an additional advantage is that **no solvents are necessary?**

What will I need in my Workspace?

Basic Set-up Suggestions

- You will need a clean level **counter** or worktable to put a heated palette on. When setting up your worktable take into consideration the space that your palette will occupy and give yourself extra room for additional materials.
- You will want to make sure that your work area has **proper ventilation**. Exhaust fans in windows, cross-ventilation, or a studio ventilation system are all good options. It is important that you have a source of fresh air in your workspace.
- It will be imperative that you have **adequate electrical outlets** available for use. Consider that you will have a palette, possibly a heat gun and/or other tools that will require electricity and it will be helpful to position your workspace accordingly.
- Keep in mind that anytime you use heated tools/equipment it is recommended that you have a **burn kit** and a **fire extinguisher** on-hand for safety purposes.

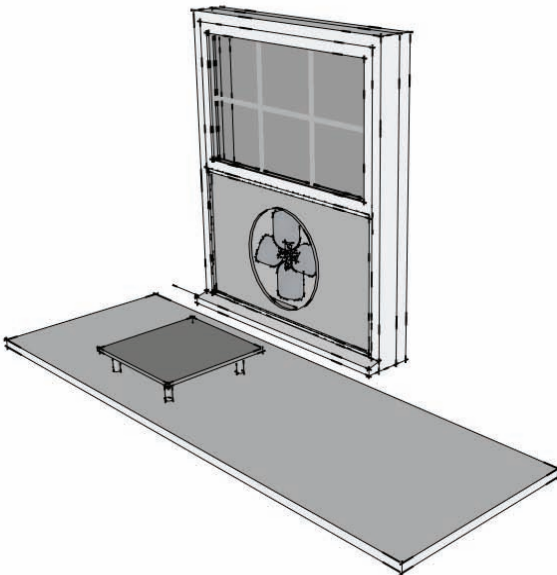

Tips and Suggestions for Equipment and Tools

There are a number of tools that you may want. Below is a listing of those items that may be helpful to your practice, but keep in mind that just like any artistic endeavor you don't need everything at once. As you become comfortable with encaustic painting you will have a better understanding of the medium and what specific tools and equipment will work best for you. We suggest the following:



- The **heated palette** is an essential tool to the encaustic artist. It provides a surface to heat and mix encaustic paint and medium on. Less expensive alternatives to purchasing a custom palette include electric skillets, crock-pots or electric griddles. R&F's heated palettes are designed specifically for encaustic painters and feature an anodized aluminum surface which prevents reactivity that could discolor pigments. The versatile aluminium surface also makes it easy to see paint colors. Regardless of the palette you select, it is important that it be equipped with temperature controls.
- A **surface thermometer** is extremely helpful in checking the temperature of your palette (the safe working temperature for encaustic paint ranges from 180-200°F).

Equipment and Tools - continued

- Select suitable **fusing tools**, such as a heat gun with variable fan speed or a tacking iron, for your work. Propane or butane torches can also be used depending on the desired effects. (*Safety Note - Be aware of your surroundings and use caution when using heated tools)
- An assortment of **natural bristle brushes** (a hake brush is a great all purpose brush). Synthetic brushes can melt when heated.
- Heavy aluminum and steel alloy **palette cups** are a convenient option to hold larger amounts of paint colors, medium and your clean-up wax.
- Various **mark-making tools** for scraping and carving. Examples include dental tools, etching tools, wood carving tools, clay working tools, razor blades, etc.





What about Paint?

Paints and other Materials for Getting Started

After you have your palette, fusing tools and brushes you will want to have a variety of encaustic paints (including encaustic medium) and soy or paraffin wax for clean-up. Encaustic medium is encaustic paint without pigment. It is used to extend colors and create transparencies.

Clean-up

There are two options for clean-up, either Soy or Paraffin wax. We recommend using soy wax for clean-up because soybeans are a renewable resource, while paraffin is a petroleum based product. An additional benefit to using soy wax is that it can be washed off with soap and water leaving brushes supple.

To clean brushes, keep a container of soy wax melted on the palette. Pour some on to the palette and work off the paint, using more cleaning wax as needed and blot your paintbrush on newsprint or paper towel.

What do I Paint on?

Supports

For best results, encaustic should be painted on a rigid, absorbent, and heat resistant surface. Examples include: wood (maple or birch plywood), heavy watercolor or printmaking paper glued to board, or raw canvas glued to board (avoid pre-gessoed canvas boards). Please note that you can use paper as your support, but you will want to consider the size and rigidity of the paper.

Three-dimensional or sculptural work that is porous and rigid can also be used. Plaster, stone, wood, terra cotta, or cast paper are all acceptable surfaces to work on.



Do I need to Prepare my Supports?

Grounds

For a prepared white ground, we suggest priming with R&F's Encaustic Gesso, which is specifically formulated for use with this medium. Our high solid acrylic gesso differs from typical acrylic gesso by having a lower proportion of binder to solid making it be more absorbent.

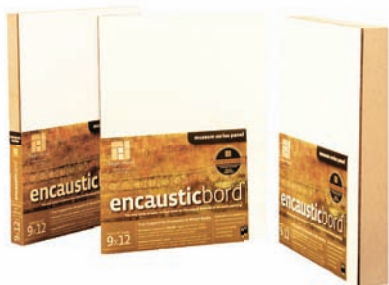

For a convenient primed panel Ampersand and R&F have partnered to introduce Encausticbord™. Encausticbord™ has a ready-to-use surface formulated for the unique demands of encaustic painting and mixed media. Available both unbraced and cradled and ready for presentation.

What do I need to know about Working with Encaustics?

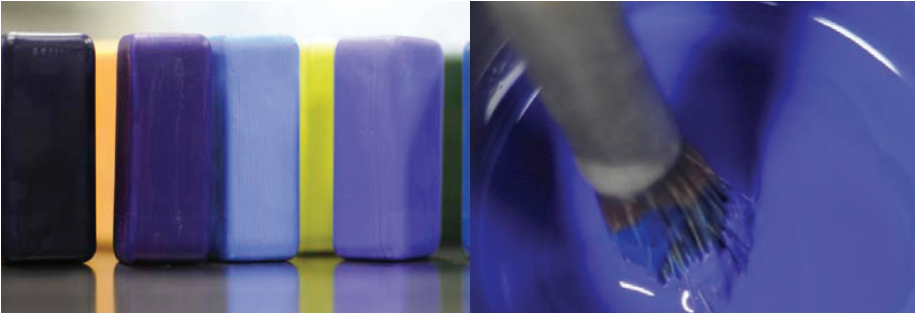

1. First Step - Melting the Paint

At room temperature encaustic paint is a solid. When heated it becomes a workable liquid. In this liquid state it can be applied to the surface with brushes, but you can also get paint on the surface by pouring, dipping or using heated tools.

Helpful Hints:

- You will want to make sure you are working within a safe temperature of 180-200°F.
- You can melt paint directly on your palette or in palette cups.
- Keep your brushes warm so that they remain soft and ready to use. You will find that if you pause with your brush the paint will cool and harden.
- The types of brushes you use will affect the way you apply the paint to the surface; a soft hake brush will leave almost no brushstrokes while a bristle brush will.
- If you apply warm paint to a warm panel the paint will flow more readily onto the board, while if you apply warm paint to a cool panel the paint will cool quickly and create texture (see Surface Effects).
- You can heat your support directly on your palette or with the use of a heat gun.

2. Second Step - Layering and Fusing

As you apply layers of paint to your support you will want to fuse (or re-heat) each layer to ensure that it is adhered to your ground or substrate. It is important to fuse between layers to prevent them from separating.



Helpful Hints:

- As you practice fusing you will notice that when the paint begins to glisten or shine that is when it is becoming molten again.
- The cooler a paint has been applied the more thoroughly it should be fused, and visa versa.
- A slow thorough fusing will result in a smooth enamel-like surface.
- If you see air bubbles in the surface of your paint a light fusing with your heat gun's hot air directed at an angle will help to get rid of them.
- Use torches and heat guns to your advantage. Not only are they for fusing, but they can also be used to move and manipulate the paint and create a wide variety of effects that cannot be achieved with a brush.

More on Fusing - What Fusing Methods are there?

Indirect Fusing Methods

Indirect fusing refers to heating the surface but not directly touching the physical surface of your painting. Examples would include using a heat gun, torches, light bulbs, or sunlight.



Direct Fusing Methods

Direct fusing refers to touching the surface with a heated tool, which is ideal for creating texture and for modeling the paint. Electric tacking irons, spatulas, and heated brushes provide uninterrupted heating. Plaster tools, palette and paint knives can be heated on the palette. Their diverse shapes give them a great range of mark making ability with differing surface effects.

3. Additional Steps

When the painting has cooled, it has reached its permanent state, but applying paint and fusing are just the beginning.

Reworking the Surface

Thus far, we have explored the additive methods most commonly used working with encaustics, but keep in mind that encaustic painting is also a subtractive medium. If you decide that you want to change your work it can be "erased" by simply scraping off or remelting the paint. There are limitless possibilities when it comes to painting, fusing and reworking your artwork.

Surface Effects

What uniquely characterizes encaustic is how heat effects the process. When the paint is warm and applied to a warm support you will achieve a smooth surface. On the other hand, when you work with paint in a cooler state you will create more texture.

If you want to develop a **smooth** enamel or glass-like finish:

1. Warm your panel before you begin painting
2. Use a soft wide brush so that you have even paint coverage
3. Overlap brushstrokes as little as possible
3. Slowly and evenly fuse your paint
4. Gently scrape your layers after you apply them to even out the paint



To build up a surface with **texture**:

1. Begin by working with a cool panel and use paint that is at a cooler temperature
2. Select a bristle brush to exaggerate texture
3. Use quick overlapping brushstrokes and minimal fusing to build up your surface
4. Repeat to build the textural surface. Keep in mind that exaggerated textures may be fragile

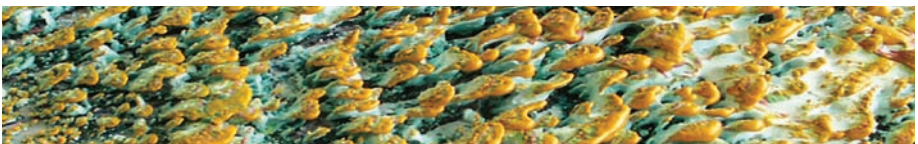

Encaustic Effects / Techniques

Layering / Glazing Effects

Glazes can be created by extending a color with the medium. They can be applied one on top of another, or separated by layers of straight medium to create unusual translucent effects. Each layer of encaustic put down should be fused. It is important to consider the opacity and translucency of the paint colors you select in this process. You can build up a high level of relief by continuing to apply layer on top of layer. For variations of surface effects, different degrees of fusing can be employed.



Scraping

As you build up layers of encaustic you can also scrape down to reveal previous layers. The reductive nature of the scraping process can expose a variety of colors and imagery that might otherwise be unseen.

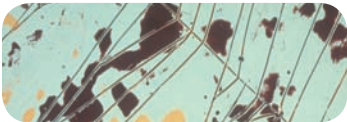

Inlay

A technique where an area of paint (usually a line) is removed and then filled with another paint color. Since encaustic cools and hardens immediately you can then scrape back any additional paint to reveal a clean flush area.



Stenciling

This method blocks off certain areas in preparation for painting. By taping off an area with either painter's tape or simply using the edge of a piece of paper you will have a high degree of control when applying the paint.

Building Your Toolbox of Techniques

Using Encaustics in Conjunction with Mixed Media

One of the characteristics of encaustic painting that has made it so adaptable and popular with a growing number of contemporary artists is its incredible versatility. It can be used in combination with almost any other medium including book arts, photography, printmaking, papermaking, ceramics, sculpture, and in installations.

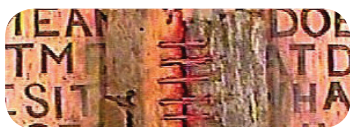

(Artwork: Margot Rubin)

Assemblage

A benefit to using encaustic is its adhesive qualities, which allow artists to incorporate a wide range of materials, both 2D and 3D into their work.



(Artwork: Judith Hoyt)

Collage

Beeswax is a natural preservative, making it an ideal material for artists who want to incorporate fragile or non-archival elements in their work.



(Artwork: Cynthia Winika)

Dipping

When paper is dipped in encaustic the wax is quickly absorbed into the natural fibers of the paper and becomes translucent when cool.



(Artwork: Paula Roland)

Encaustic Monotype

Images can be created directly on a heated palette and then lifted onto a piece of paper much the same way that a monotype is made in printmaking.

Building Your Toolbox of Techniques - continued



(Artwork: Karen Bubb)

Image Transfer Techniques

For those who want to incorporate images, there are several techniques for transferring imagery from paper to an encaustic surface that include graphite and photocopy transfer.



(Artwork: Kim Bernard)

Sculptural Applications

Encaustic offers limitless possibilities to artists seeking to work 3-dimensionally. It can be cast, carved, or built-up quickly.



(Artwork: Laura Moriarty)

Pouring

A technique that can be used to build up the surface with encaustic without using brushes.



(Artwork: Cynthia Winika)

Book Arts

When encaustic is absorbed into thin fiber-based papers it makes the paper translucent which can be used to create varied effects in artist books. Dipping paper also gives an additional weight or body that lends itself to being sewn.

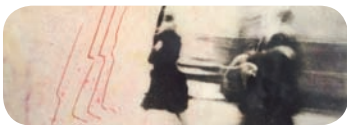

(Artwork: Jill Skupin Burkholder)

Photo and Encaustic

Combining the encaustic process with traditional and experimental photographic images can create ephemeral effects.

The background is an abstract composition of vibrant colors and textures. It features broad, expressive brushstrokes in shades of blue, yellow, orange, and red. The colors are layered and blended, creating a sense of depth and movement. The overall effect is that of a dynamic, artistic surface, possibly a canvas or a piece of paper that has been painted with thick, textured paint.

Good luck as you get started!

R&F Handmade Paints began manufacturing professional artists paints and providing artist-focused technical support in 1988. Today, R&F distinguishes itself by continuing to craft the highest quality paint in small, carefully controlled batches where the eye and skill of the paintmaker are key. R&F's distinct product line includes two types of paint: our classic wax-based encaustic paint and luscious, linseed oil based Pigment Sticks®.

rfpaints.com
800.206.8088